

PORTAIL



**ATOUT**  
FERMETURES



GAMME DE PORTAIL DESIGN

SUR-MESURE



[www.atout-fermetures.com](http://www.atout-fermetures.com)



# ATOUT FERMETURES

Chez atout-fermetures.com, nous savons que "Travaux à la maison" rime trop souvent avec retard, imprévus et complications... Pour que votre pose de menuiserie se passe sans encombre, l'équipe d'Atout-fermetures se plie en quatre pour : Concevoir, fabriquer, livrer des menuiseries sur-mesure performantes, aux meilleurs prix, dans les meilleurs délais.



 **MERCI !**

de nous témoigner votre  
confiance au quotidien



 **DEVIS  
SUR MESURE**

 **LIVRAISON  
SUR TOUTE LA FRANCE**

 **FABRICATION  
PORTUGAL**

MATERIAUX PORTAILS ALUMINIUM 3

GAMME DESIGN 4 - 13

PRENDRE LES COTES D'UN PORTAIL 14

ÉLECTRICITÉ MAÇONNERIE POUR PORTAIL 15

NOTICE DE POSE PORTAIL COULISSANT 16 - 17

NOTICE DE POSE PORTAIL BATTANT 18 - 19



## AVANTAGES

### DU PORTAIL ALUMINIUM

Avant tout pour délimiter et sécuriser votre habitation le portail ATOUT FERMETURES est entièrement réalisé en aluminium. Ce matériaux est notamment réputé pour sa légèreté et sa résistance qui offre une longévité maximale. Tous nos portails sont traités contre la rouille et la corrosion.

## QUALITÉ ET ESTHÉTISME

Notre gamme de portails vous offre la possibilité de choisir un portail adapté à l'esthétique de votre maison avec plus de 50 modèles.

## COLORIS



BLANC  
RAL 9016



GRIS  
RAL 7016



VERT  
RAL 6005



ROUGE  
RAL 6004



MARRON  
RAL 8014

## ENTRETIEN FACILE & RAPIDE

Nos portails aluminium demandent peu d'entretien, grâce à un thermolaquage de haute résistance, leur brillance est préservée et le coloris conserve son éclat. Le nettoyage quant à lui se réalise avec une éponge et de l'eau tiède.

ACCESSOIRES  
100% ALUMINIUM



RENFORTS DE  
MOTORISATION



## CARACTÉRISTIQUES TECHNIQUES

### gamme CLASSIQUE

- ▶ Profils en aluminium assemblés par tenons et mortaises
- ▶ Montant verticaux : 100 x 54mm
- ▶ Traverses horizontales 90 x 36mm
- ▶ Lame de remplissage : 100 x 16mm
- ▶ Epaisseur des profils : 2mm

### gamme MODERN, SEMI MODERN et DESIGN

- ▶ Montant verticaux : 100 x 54mm
- ▶ Traverses horizontales 90 x 36mm
- ▶ Lame de remplissage : 200 x 16mm (modèles lames larges)
- ▶ Epaisseur des profils : 2.5mm
- ▶ \* Insert en alunox
- ▶ \*\* Vitrage feuilleté 33.2 dépoli

### Le label QUALICOAT

garantit un niveau de qualité maximum pour le thermolaquage de votre portail ou portillon. Ce dernier comprend une préparation de surface, une conversion chimique, l'application de la laque et la cuisson au four.





**PORTAIL** AT DS01



INSERTS  
ALUNOX



► Profilé en aluminium extrudé ► Renfort motorisation ► Thermolaquage label Qualicoat qualité marine



Portail coulissant



Portail Battant



Portillon

COLORIS



BLANC  
RAL 9016



GRIS  
RAL 7016



VERT  
RAL 6005



ROUGE  
RAL 6004



MARRON  
RAL 8014

**PORTAIL** AT DS02



INSERTS  
ALUNOX



VITRAGE FEUILLETÉ  
33.2 DEPOLI



► Profilé en aluminium extrudé ► Renfort motorisation ► Thermolaquage label Qualicoat qualité marine



Portail coulissant



Portail Battant



Portillon



Anticorrosion



Renfort  
motorisation



Sur mesure

**PORTAIL** AT DS03



VITRAGE FEUILLETÉ  
33.2 DEPOLI



► Profilé en aluminium extrudé ► Renfort motorisation ► Thermolaquage label Qualicoat qualité marine



Portail coulissant



Portail Battant

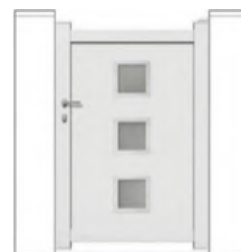

Portillon

COLORIS

BLANC  
RAL 9016

GRIS  
RAL 7016

VERT  
RAL 6005

ROUGE  
RAL 6004

MARRON  
RAL 8014

**PORTAIL** AT DS04



INSERTS  
ALUNOX



► Profilé en aluminium extrudé ► Renfort motorisation ► Thermolaquage label Qualicoat qualité marine



Portail coulissant



Portail Battant



Portillon



Anticorrosion



Renfort  
motorisation



Sur mesure

**PORTAIL** AT DS05

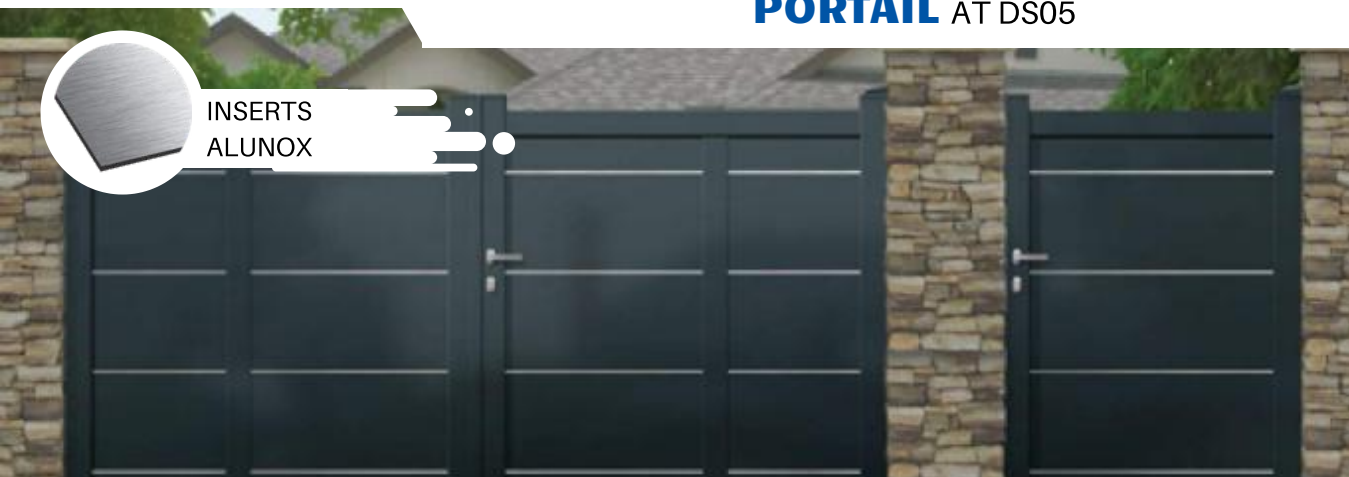

► Profilé en aluminium extrudé ► Renfort motorisation ► Thermolaquage label Qualicoat qualité marine

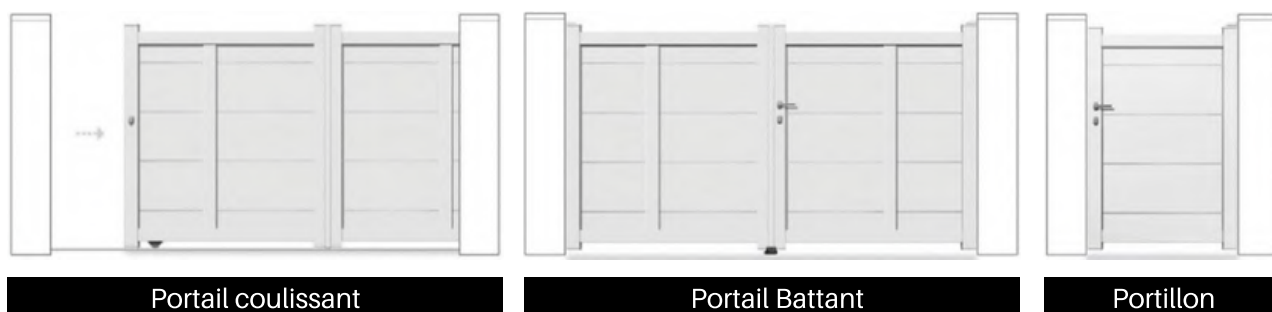

**COLORIS**

  
BLANC  
RAL 9016

  
GRIS  
RAL 7016

  
VERT  
RAL 6005

  
ROUGE  
RAL 6004

  
MARRON  
RAL 8014

**PORTAIL** AT DS06



► Profilé en aluminium extrudé ► Renfort motorisation ► Thermolaquage label Qualicoat qualité marine

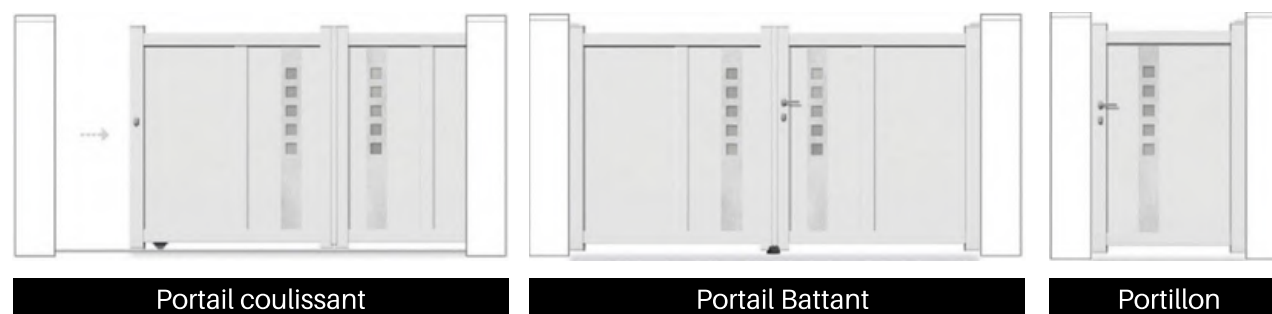

Anticorrosion



Renfort  
motorisation



Sur mesure



**PORTAIL** AT DS07



VITRAGE FEUILLETÉ  
33.2 DEPOLI



► Profilé en aluminium extrudé ► Renfort motorisation ► Thermolaquage label Qualicoat qualité marine



Portail coulissant



Portail Battant



Portillon

COLORIS



BLANC  
RAL 9016



GRIS  
RAL 7016



VERT  
RAL 6005



ROUGE  
RAL 6004



MARRON  
RAL 8014

**PORTAIL** AT DS08



INSERTS  
ALUNOX



► Profilé en aluminium extrudé ► Renfort motorisation ► Thermolaquage label Qualicoat qualité marine



Portail coulissant



Portail Battant



Portillon



Anticorrosion



Renfort  
motorisation



Sur mesure

**PORTAIL** AT DS09

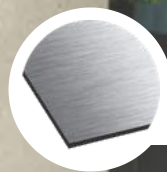

INSERTS  
ALUNOX



► Profilé en aluminium extrudé ► Renfort motorisation ► Thermolaquage label Qualicoat qualité marine



Portail coulissant



Portail Battant



Portillon

COLORIS

BLANC  
RAL 9016

GRIS  
RAL 7016

VERT  
RAL 6005

ROUGE  
RAL 6004

MARRON  
RAL 8014

**PORTAIL** AT DS10



INSERTS  
ALUNOX



VITRAGE FEUILLETÉ  
33.2 DEPOLI



► Profilé en aluminium extrudé ► Renfort motorisation ► Thermolaquage label Qualicoat qualité marine



Portail coulissant



Portail Battant



Portillon



Anticorrosion



Renfort  
motorisation



Sur mesure



**PORTAIL** AT DS11



INSERTS  
ALUNOX



VITRAGE FEUILLETÉ  
33.2 DEPOLI

► Profilé en aluminium extrudé ► Renfort motorisation ► Thermolaquage label Qualicoat qualité marine



Portail coulissant



Portail Battant



Portillon

COLORIS



BLANC  
RAL 9016



GRIS  
RAL 7016



VERT  
RAL 6005



ROUGE  
RAL 6004



MARRON  
RAL 8014

**PORTAIL** AT DS12



INSERTS  
ALUNOX

► Profilé en aluminium extrudé ► Renfort motorisation ► Thermolaquage label Qualicoat qualité marine



Portail coulissant



Portail Battant



Portillon



Anticorrosion



Renfort  
motorisation



Sur mesure

**PORTAIL** AT DS13



INSERTS  
ALUNOX



VITRAGE FEUILLETÉ  
33.2 DEPOLI



► Profilé en aluminium extrudé ► Renfort motorisation ► Thermolaquage label Qualicoat qualité marine



Portail coulissant



Portail Battant



Portillon

**COLORIS**



BLANC  
RAL 9016



GRIS  
RAL 7016



VERT  
RAL 6005



ROUGE  
RAL 6004



MARRON  
RAL 8014

**PORTAIL** AT DS14



INSERTS  
ALUNOX



VITRAGE FEUILLETÉ  
33.2 DEPOLI



► Profilé en aluminium extrudé ► Renfort motorisation ► Thermolaquage label Qualicoat qualité marine



Portail coulissant



Portail Battant



Portillon



Anticorrosion



Renfort  
motorisation



Sur mesure

**PORTAIL** AT DS15



INSERTS  
ALUNOX

► Profilé en aluminium extrudé ► Renfort motorisation ► Thermolaquage label Qualicoat qualité marine

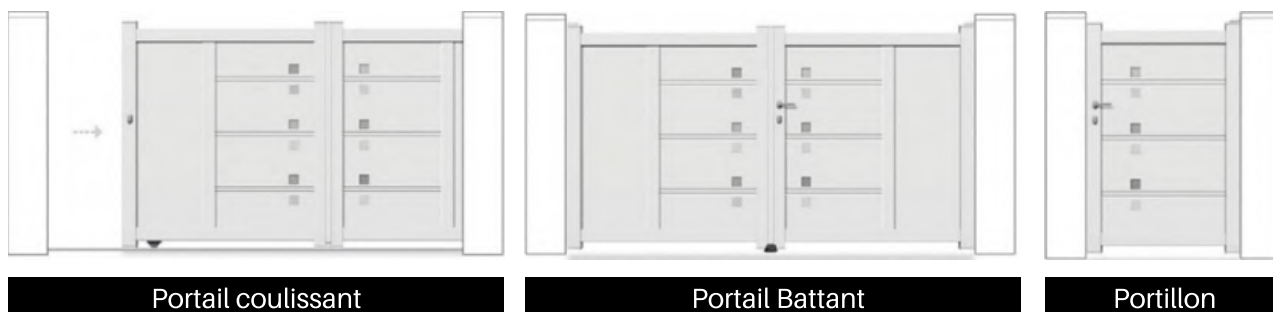

Portail coulissant

Portail Battant

Portillon

**COLORIS**

BLANC  
RAL 9016

GRIS  
RAL 7016

VERT  
RAL 6005

ROUGE  
RAL 6004

MARRON  
RAL 8014

**PORTAIL** AT DS16



INSERTS  
ALUNOX

VITRAGE FEUILLETÉ  
33.2 DEPOLI

► Profilé en aluminium extrudé ► Renfort motorisation ► Thermolaquage label Qualicoat qualité marine

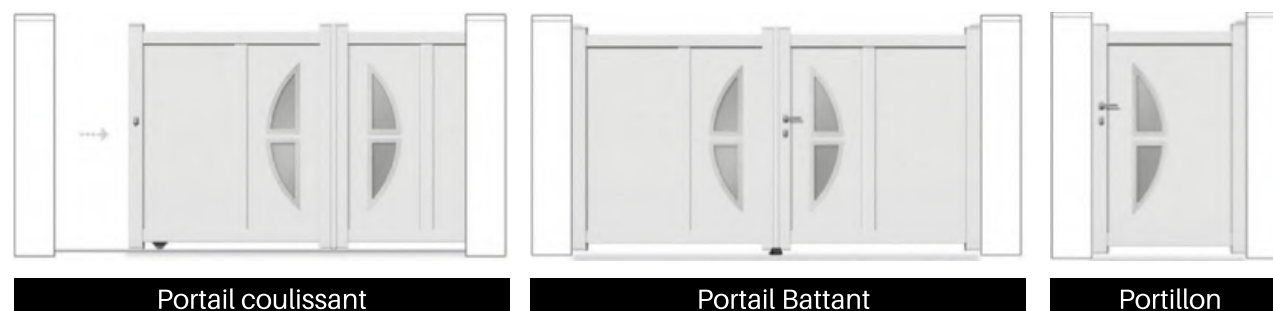

Portail coulissant

Portail Battant

Portillon



Anticorrosion



Renfort  
motorisation



Sur mesure



**PORTAIL** AT DS17



VITRAGE FEUILLETÉ  
33.2 DEPOLI



► Profilé en aluminium extrudé ► Renfort motorisation ► Thermolaquage label Qualicoat qualité marine



Portail coulissant



Portail Battant



Portillon

**COLORIS**



BLANC  
RAL 9016



GRIS  
RAL 7016



VERT  
RAL 6005



ROUGE  
RAL 6004



MARRON  
RAL 8014

**PORTAIL** AT DS18



INSERTS  
ALUNOX



VITRAGE FEUILLETÉ  
33.2 DEPOLI



► Profilé en aluminium extrudé ► Renfort motorisation ► Thermolaquage label Qualicoat qualité marine



Portail coulissant



Portail Battant



Portillon



Anticorrosion



Renfort  
motorisation



Sur mesure

**PORTAIL** AT DS19



► Profilé en aluminium extrudé ► Renfort motorisation ► Thermolaquage label Qualicoat qualité marine



Portail coulissant



Portail Battant



Portillon

**COLORIS**

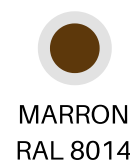
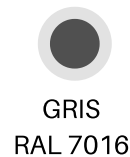

**PORTAIL** AT DS20

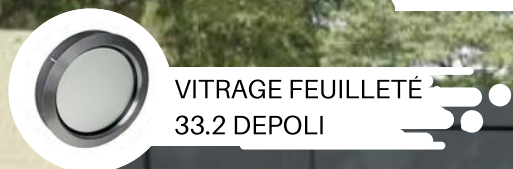

► Profilé en aluminium extrudé ► Renfort motorisation ► Thermolaquage label Qualicoat qualité marine



Portail coulissant



Portail Battant



Portillon



Anticorrosion



Renfort  
motorisation



Sur mesure

ATOUT FERMETURES, fabricant de portail sur mesure vous offre la possibilité d'ajuster votre portail à votre entrée au millimètres près.

## Les outils

Pour bien prendre vos dimensions entre piliers, utilisez **un mètre ruban** ou un **télémètre laser** le cas échéant pour une plus grande précision, prenez aussi de quoi de noter pour un schéma de votre calepinage.

## Notre conseil

En cas de différence sur la largeur entre poteau il est préférable de prendre la dimension à **3 niveaux** et nous indiquer la plus petite côte relevée. Il est aussi recommandé de contrôler la verticalité des piliers à l'aide soit d'un fil à plomb, ou d'un niveau.

## RÉUSSIR SA PRISE DE COTES

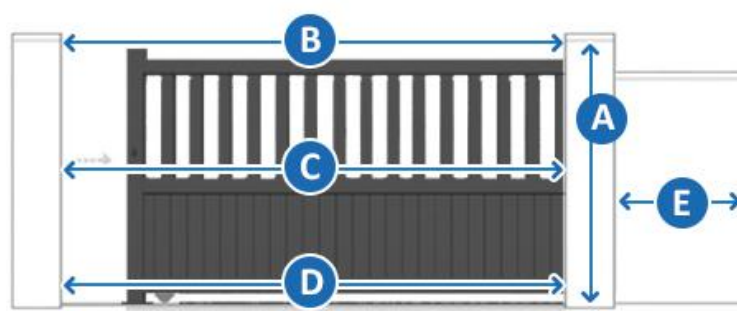
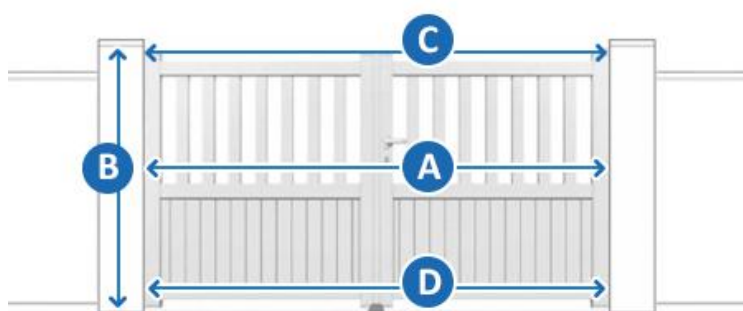

Les mesures sont à renseigner en Millimètres exemple : 2.5m=2500mm

Renseignez les mesures

Portail BATTANT

Largeur entre piliers milieu

A) .....mm

Hauteur du pilier sous chapeau

B) .....mm

Largeur entre piliers hauts

C) .....mm

Largeur entre piliers bas

D) .....mm

Renseignez les mesures

Portail COULISSANT

Hauteur du pilier sous chapeau

A) .....mm

Largeur entre piliers hauts

B) .....mm

Largeur entre piliers milieu

C) .....mm

Largeur entre piliers bas

D) .....mm

Profondeur de refoulement

E) .....mm + une marge de sécurité de minimum 15cm

Si votre maçonnerie n'est pas encore faite, deux solutions s'offrent à vous :

- 1 ► Faites appel à un maçon pour la mise en place des piliers.
- 2 ► ATOUT-FERMETURES vous propose ses poteaux aluminium (150 x 150 mm) adapté à la hauteur de votre portail.

Vous n'avez pas de pilier ?

Fixation des piliers avec scellement sur la longueur du piler pour qu'il puisse être sceller dans le muret.

OU





Fixation des piliers à visser

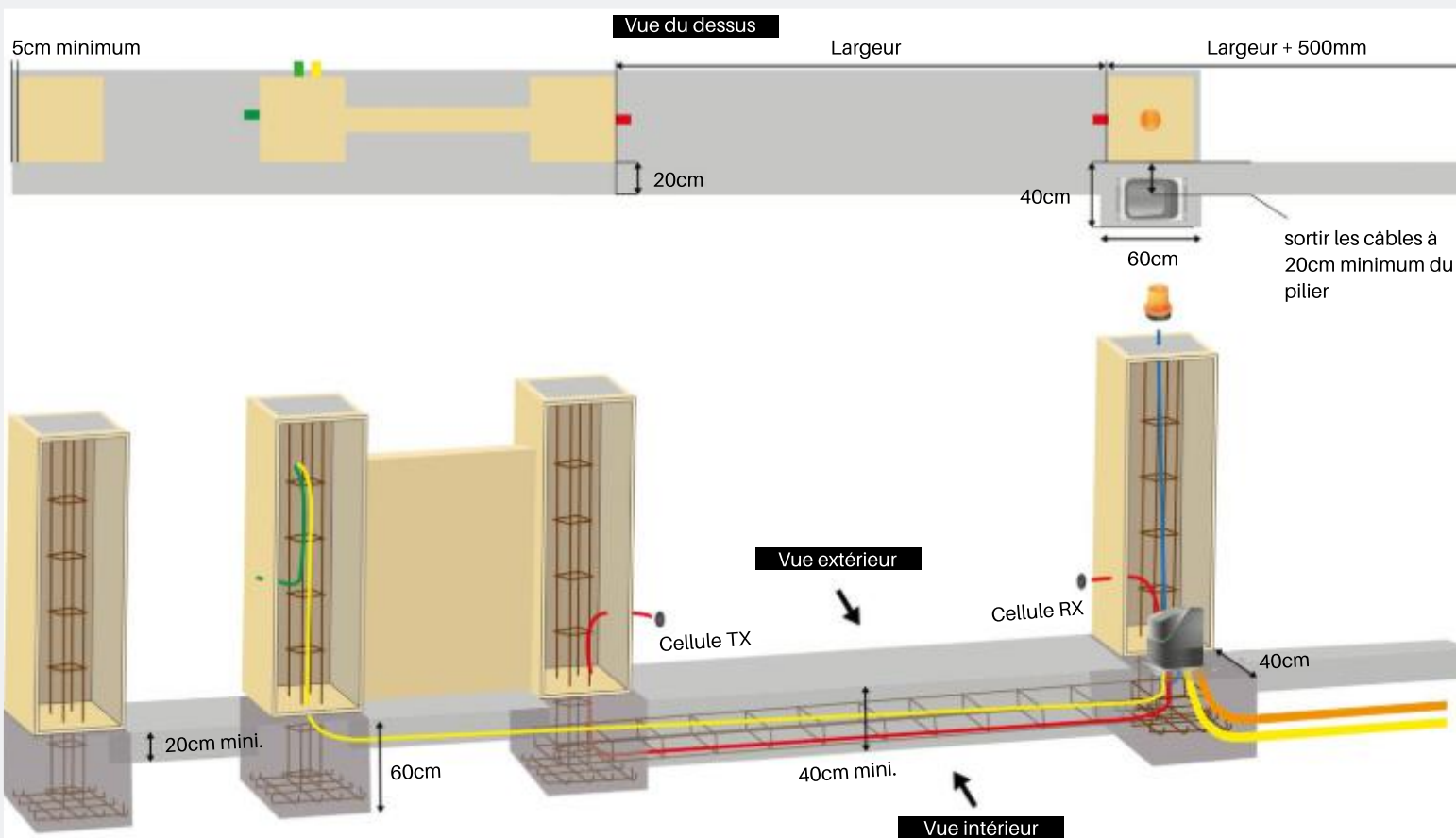

**SCHEMA D'IMPLANTATION DU MATÉRIEL ÉLECTRIQUE ET RÈGLES DE MAÇONNERIE PRÉALABLE A L'INSTALLATION**

Pour anticiper au mieux vos travaux et la mise en place de votre futur équipement, nous mettons à votre disposition un schéma indiquant l'emplacement des réserves à prévoir pour installer les différents équipements électrique et les règles de maçonnerie à respecter avant l'installation de votre portail.



-  Alimentation 230v  
3x fils / diamètre 1.5mm
-  Interphone visiophone 12v  
4x fils ou 2x fils téléphone ou réseau
-  Gyrophare antenne 12v/24v  
2x fils téléphone ou réseau
-  Cellules 12v  
RX (4x fils) / TX (2x fils) téléphone ou réseau
-  Serrure électrique 12v  
RX (4x fils) / TX (2x fils) téléphone ou réseau



### ► LE MATÉRIEL

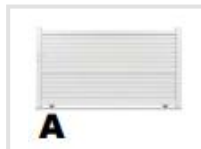
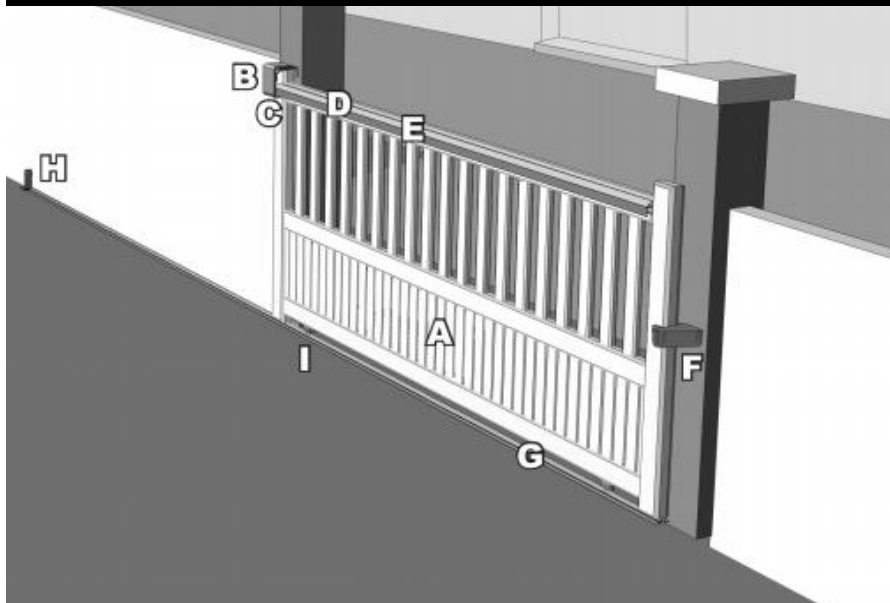

1x vantail



platine de guidage



patin de glissement



rail de guidage supérieur



profilé de clipage



gâche



rail inférieur



butée



support de rail

### ► LES OUTILS



Pour poser vous aurez besoin des outils suivant :

- 1x perforateur et ses forets à métaux
- 1x perceuse/visseuse
- 1x marteau/maillet
- 1x crayon
- Clés plate - à pipe - Allen
- 1x mètre
- 1x cordeau à tracer
- 1x niveau à bulle
- 1x règle de maçon
- chevilles à bétons
- serre-joints

### 1 ► RAIL DE GUIDAGE SUPÉRIEUR



1.1

- MONTER LE RAIL DE GUIDAGE SUPÉRIEUR
- LE CENTRER SUR LA TRAVERSE HAUTE DU PORTAIL

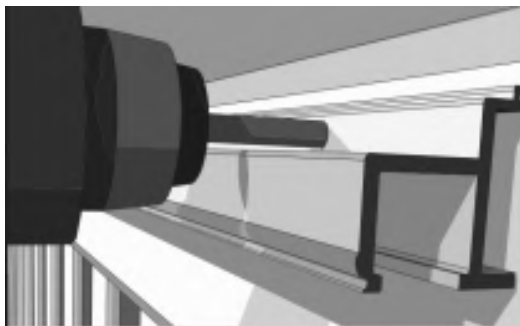

1.2

- UTILISER LES PRÉ-PERÇAGES DU RAIL DE GUIDAGE COMME RÉFÉRENCE
- PERCER (diamètre 3.75mm)

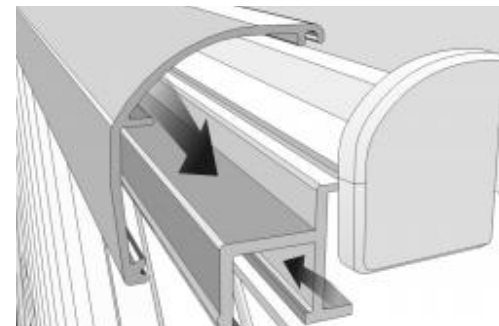

1.3

- MONTER LE PROFILÉ DE CLIPAGE SUR LE RAIL DE GUIDAGE SUPÉRIEUR
- METTRE LES EMBOUTS



## 2 ► RAIL INFÉRIEUR

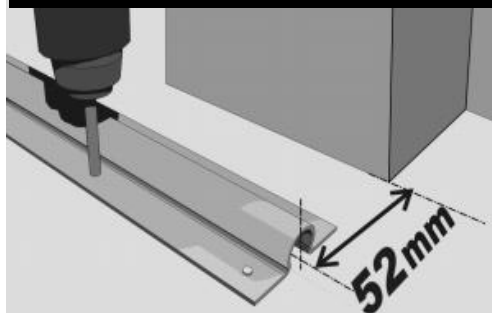

2.1

- POSITIONNER ET FIXER LE RAIL INFÉRIEUR AU SOL A DISTANCE INDIQUÉE ENTRE LE PILIER ET LE RAIL INFÉRIEUR

## 3 ► RAIL INFÉRIEUR

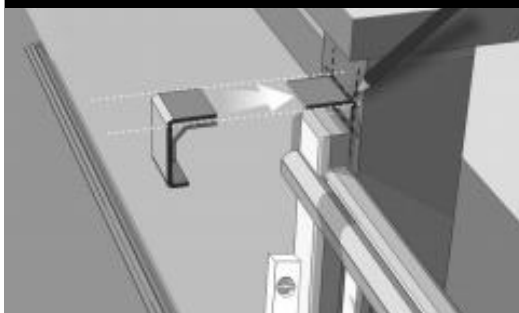

3.1

- POSITIONNER LE PORTAIL SUR LE RAIL INFÉRIEUR
- VÉRIFIER L'APLOMB ET MARQUER L'EMPLACEMENT DE LA PLATINE DE GUIDAGE SUR LE PILIER



3.2

- FIXER LA PLATINE DE GUIDAGE COMPLÈTE SUR LE PILIER AVEC LA PATIN DE GUIDAGE

## 4 ► PLATINE DE GUIDAGE



4.1

- MONTER LE PORTAIL SUR LE RAIL INFÉRIEUR
- LE FAIRE COULISSER AVEC LE PATIN DE GLISSEMENT DANS LE RAIL DE GUIDAGE SUPÉRIEUR

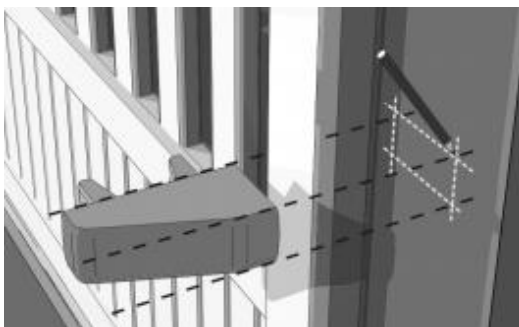

4.2

- MARQUER LA POSITION DE LA GÂCHE SUR LE DEUXIÈME PILIER ET LA FIXER

## 5 ► FIXATION DE LA BUTÉE



5.1

- VÉRIFIER LA POSITION DE LA BUTÉE POUR QUE LE PORTAIL NE SORTE PAS DE LA PLATINE

## 6 ► REGLAGE DE LA PLATINE

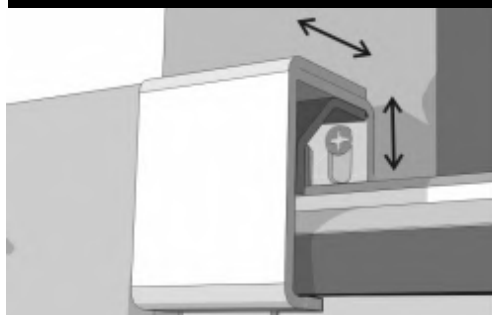

6.1

- SI NÉCESSAIRE, RÉGLER LA HAUTEUR ET LA PROFONDEUR DE LA PLATINE DE GUIDAGE POUR OPTIMISER LE FONCTIONNEMENT DU PORTAIL

## 7 ► L'ENTRETIEN

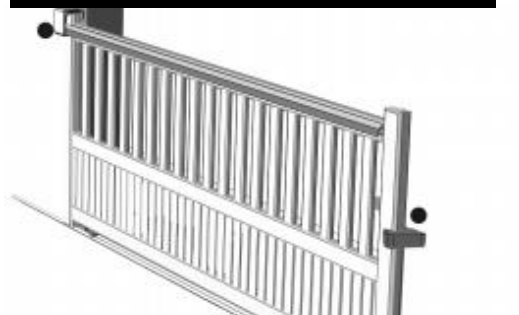

7.1

- L'ENTRETIEN SE FAIT RÉGULIÈREMENT AVEC UNE EAU TIÈDE SAVONNEUSE ET UNE PEAU DE CHAMOIS







### ► LE MATÉRIEL

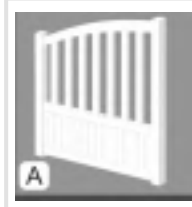
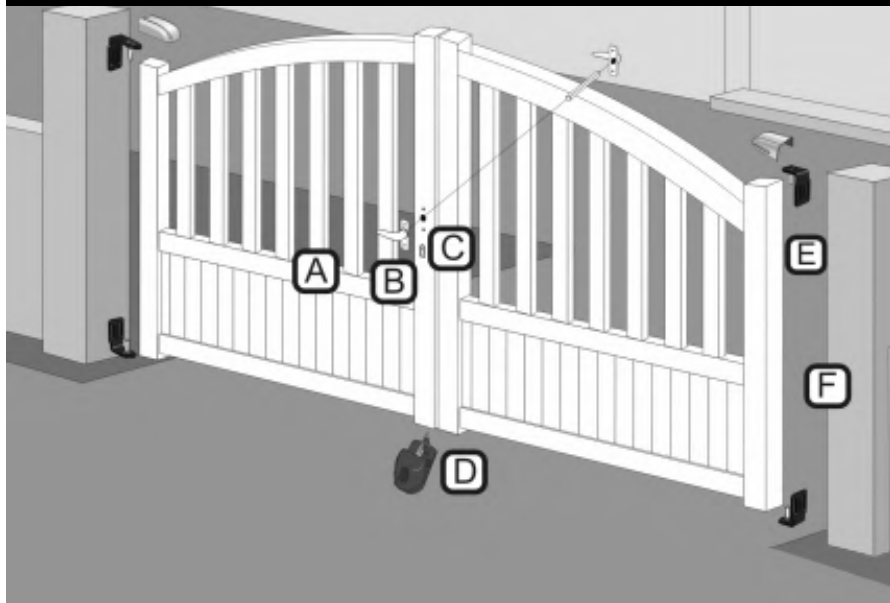

2x vantaux

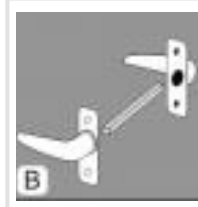

2x poignées

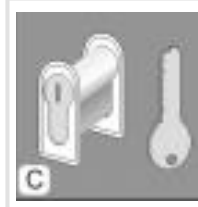

1x serrure à clés

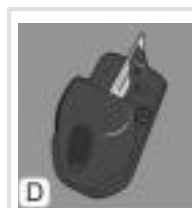

1x sabot



4x gonds



1x gâche

### ► LES OUTILS



Pour poser vous aurez besoin des outils suivant :

- 1x perforateur et ses forets à métaux
- 1x perceuse/visseuse
- 1x marteau/maillet
- 1x crayon
- Clés plate - à pipe - Allen
- 1x mètre
- 1x cordeau à tracer
- 1x niveau à bulle
- 1x règle de maçon
- chevilles à bétons
- serre-joints

### 1 ► ACCESSOIRES EN SITUATION

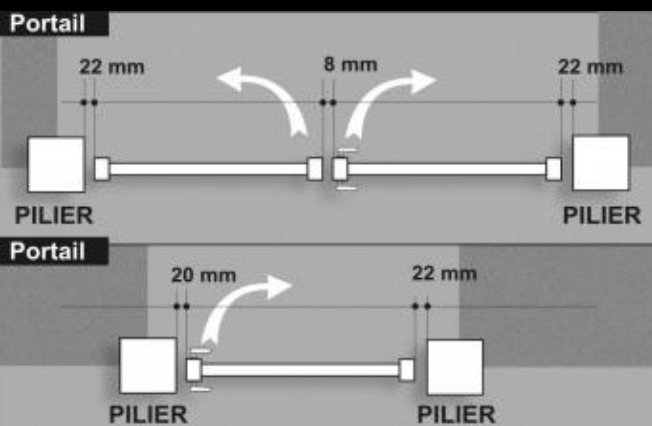

1.1

### 2 ► VÉRIFICATION DE L'ÉQUERAGE

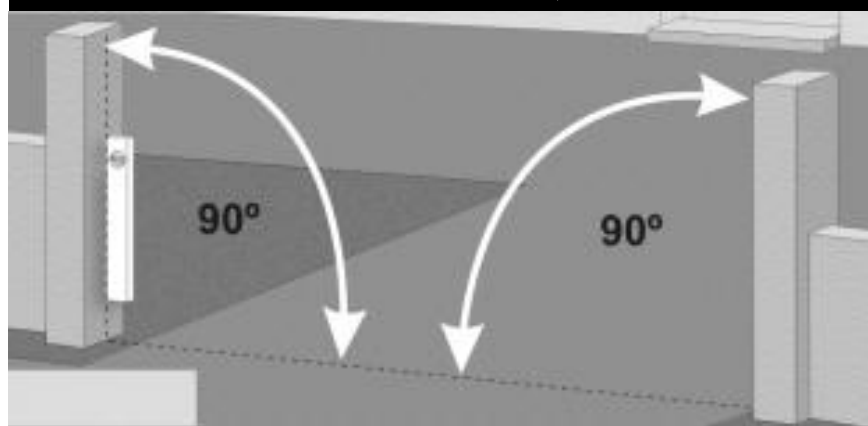

2.1

► VÉRIFIER L'ÉQUERAGE ET L'APLOMB DES DEUX PILIERS

3 ► FIXATION DE LA POIGNÉE

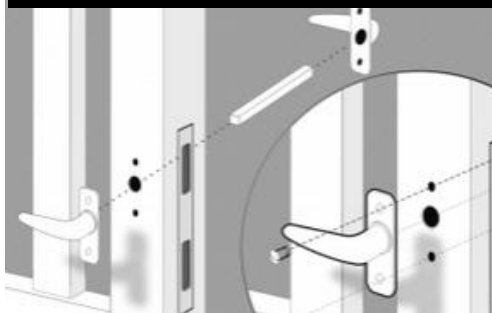

3.1

- MONTER LA DOUBLE POIGNÉE AVEC LE CARRÉ

4 ► POSE DES GONDS

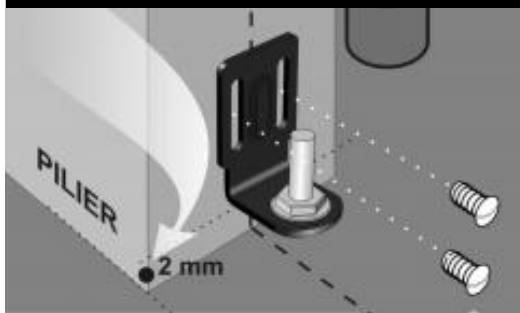

4.1

- FIXER SUR LE PILIER LE GOND BAS, A 2mm DU SOL
- VÉRIFIER L'APLOMB

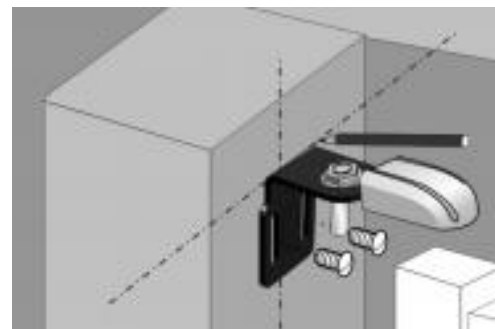

4.2

- MONTER LE VANTAIL SUR LE GOND DU BAS
- TRACER L'EMPLACEMENT DU GOND HAUT

5 ► MONTAGE DES VANTAUX



5.1

- VISSER LE GOND HAUT DU PILIER SANS TROP SERRER
- POSER LE VANTAIL SUR LE GOND DU BAS
- AJUSTER LE GOND EN HAUTEUR PUIS VISSER SUR LE PILIER
- PLACER LE CACHE GOND POUR OCCULTER LE VERROU
- EFFECTUER LA MÊME OPÉRATION POUR L'AUTRE VANTAIL



5.2

- A L'AIDE D'UNE RÈGLE ALIGNER LES 2 VANTAUX, DE L'INTÉRIEUR
- POSITIONNER LE SABOT ET LE TRACER, POUR FINALEMENT LE FIXER

6 ► L'ENTRETIEN



6.1

- L'ENTRETIEN SE FAIT RÉGULIÈREMENT AVEC UNE EAU TIÈDE SAVONNEUSE ET UNE PEAU DE CHAMOIS





# 1

## EQUIPE DE PROFESSIONNELLES A VOTRE ÉCOUTE

CONSEILS

DEVIS, COMMANDES

RETRAIT MARCHANDISE

LIVRAISON

# ATOUT

## FERMETURES

Atout-Fermetures se positionne comme un acteur majeur sur tout type de menuiserie en ligne. Du choix de votre portail, porte de garage ou votre grillage jusqu'à son installation finale, vous êtes accompagné(e) par un expert. Alors plus de temps à perdre, c'est par ici que ça se passe ...

## ATOUT FERMETURES

📞 04 42 49 19 17

✉ contact@atout-fermetures.com

📍 05 Rue de Stockholm  
13127 Vitrolles

Ouvert tous les jours de :

**09h00 à 12h00**

**14h00 à 18h00**

*sauf le samedi et dimanche*

